

This Page Is Inserted by IFW Operations  
and is not a part of the Official Record

## **BEST AVAILABLE IMAGES**

Defective images within this document are accurate representations of the original documents submitted by the applicant.

Defects in the images may include (but are not limited to):

- BLACK BORDERS
- TEXT CUT OFF AT TOP, BOTTOM OR SIDES
- FADED TEXT
- ILLEGIBLE TEXT
- SKEWED/SLANTED IMAGES
- COLORED PHOTOS
- BLACK OR VERY BLACK AND WHITE DARK PHOTOS
- GRAY SCALE DOCUMENTS

**IMAGES ARE BEST AVAILABLE COPY.**

**As rescanning documents *will not* correct images,  
please do not report the images to the  
Problem Image Mailbox.**

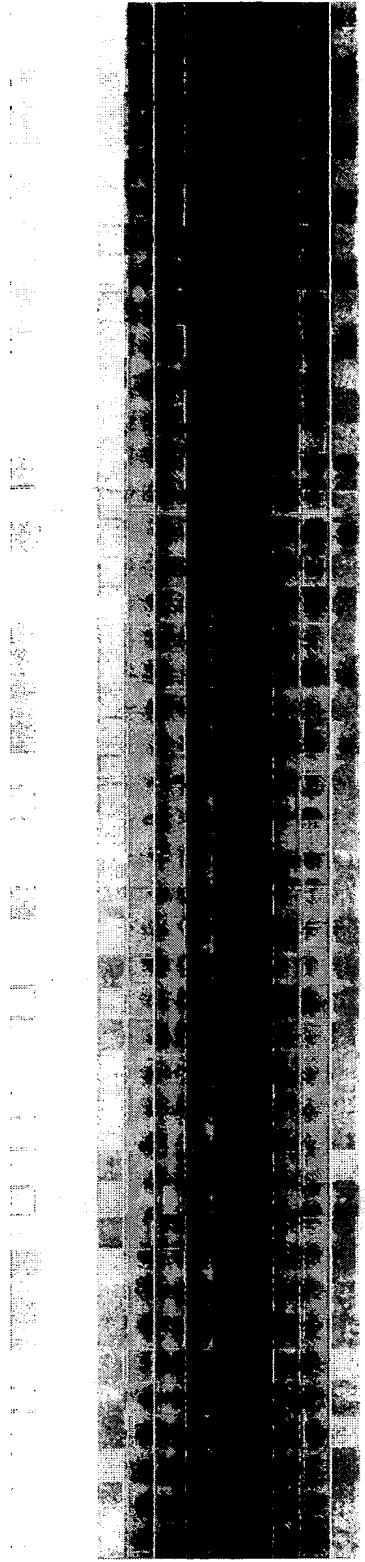

FIG. 1

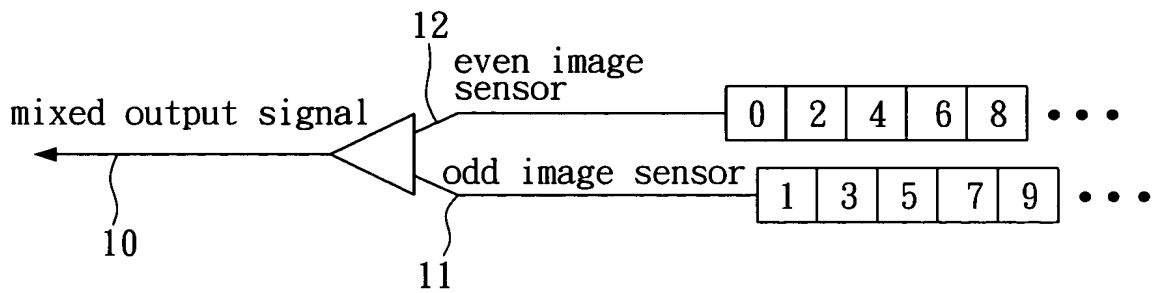

FIG. 2

P <sub>00</sub>	P <sub>01</sub>	P <sub>02</sub>	P <sub>03</sub>	P <sub>04</sub>	P <sub>05</sub>	P <sub>06</sub>	P <sub>07</sub>	P <sub>08</sub>	P <sub>09</sub>	••• Line0
P <sub>10</sub>	P <sub>11</sub>	P <sub>12</sub>	P <sub>13</sub>	P <sub>14</sub>	P <sub>15</sub>	P <sub>16</sub>	P <sub>17</sub>	P <sub>18</sub>	P <sub>19</sub>	••• Line1
P <sub>20</sub>	P <sub>21</sub>	P <sub>22</sub>	P <sub>23</sub>	P <sub>24</sub>	P <sub>25</sub>	P <sub>26</sub>	P <sub>27</sub>	P <sub>28</sub>	P <sub>29</sub>	••• Line2
P <sub>30</sub>	P <sub>31</sub>	P <sub>32</sub>	P <sub>33</sub>	P <sub>34</sub>	P <sub>35</sub>	P <sub>36</sub>	P <sub>37</sub>	P <sub>38</sub>	P <sub>39</sub>	••• Line3
P <sub>40</sub>	P <sub>41</sub>	P <sub>42</sub>	P <sub>43</sub>	P <sub>44</sub>	P <sub>45</sub>	P <sub>46</sub>	P <sub>47</sub>	P <sub>48</sub>	P <sub>49</sub>	••• Line4

FIG. 3

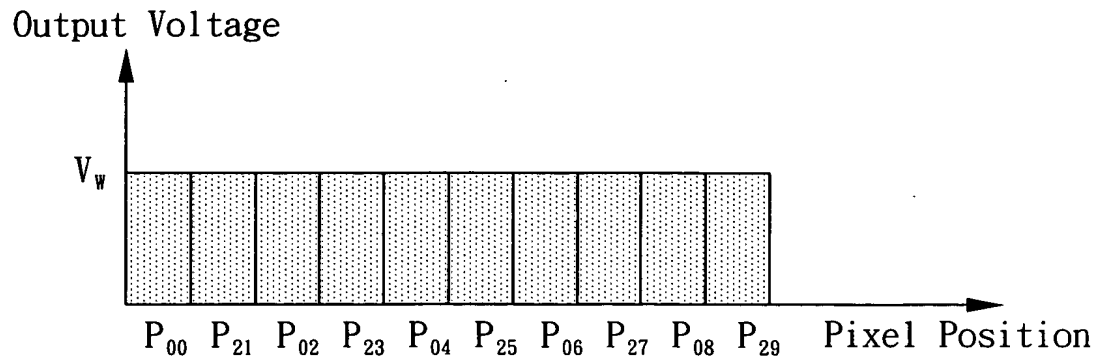

FIG. 4A

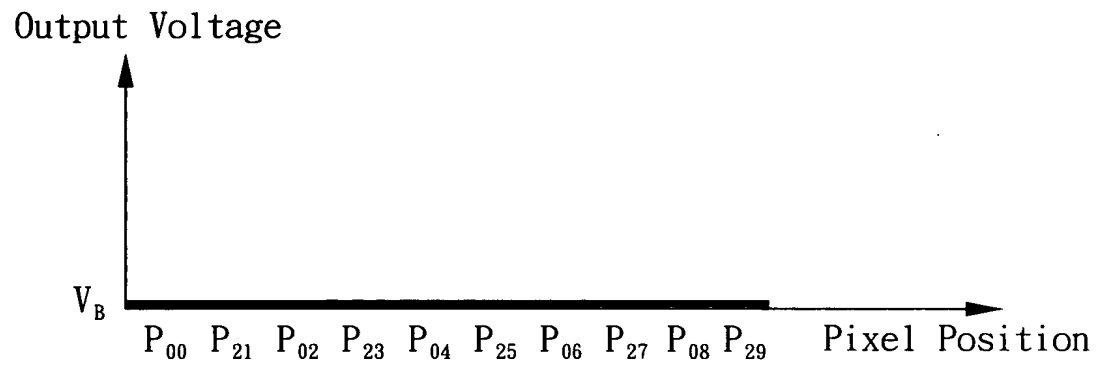

FIG. 4B

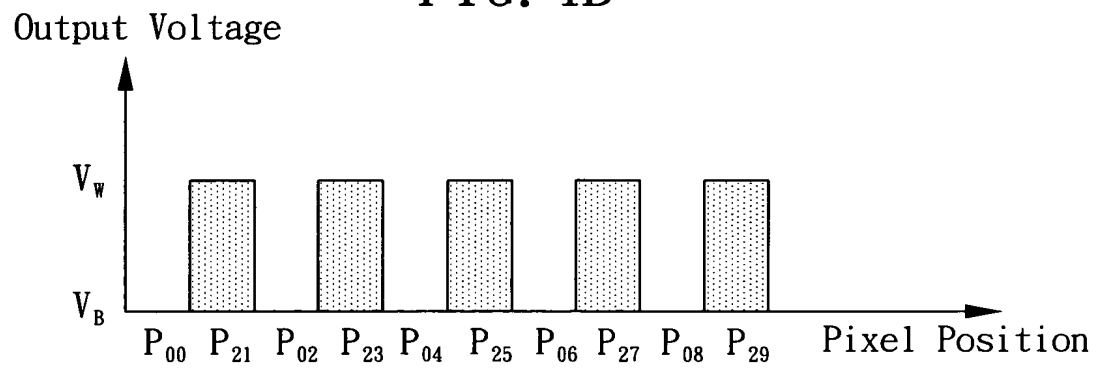

FIG. 4C

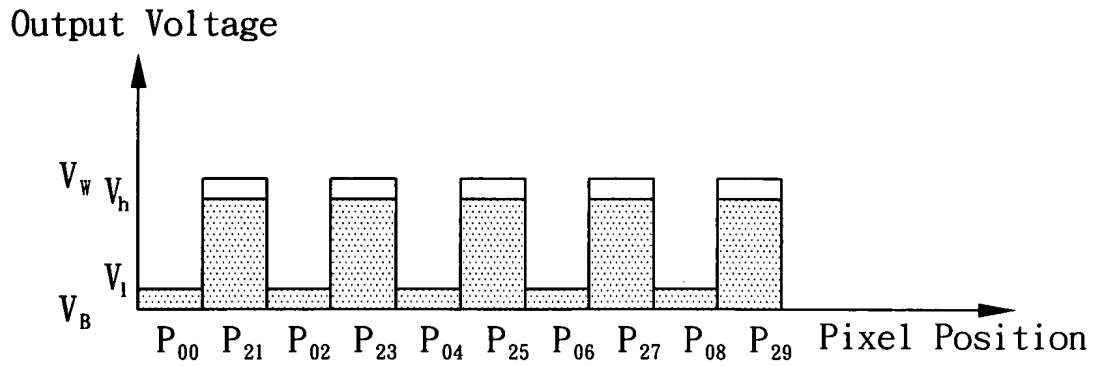

FIG. 4D

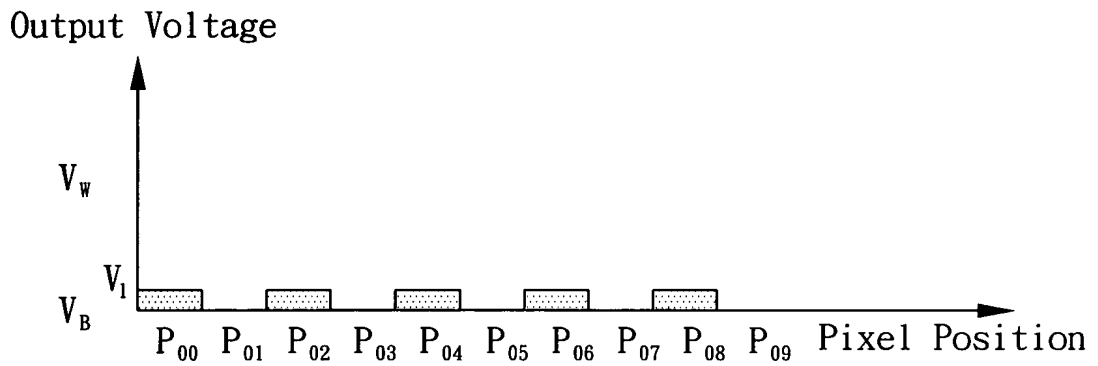

FIG. 4E

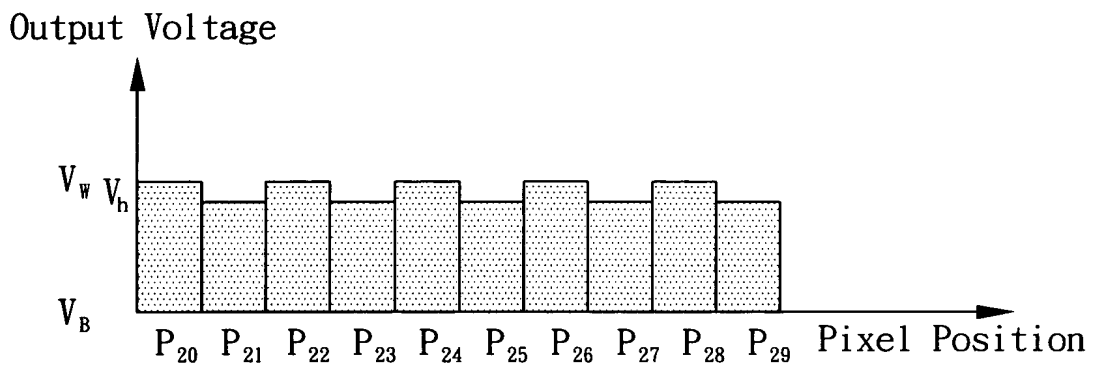

FIG. 4F

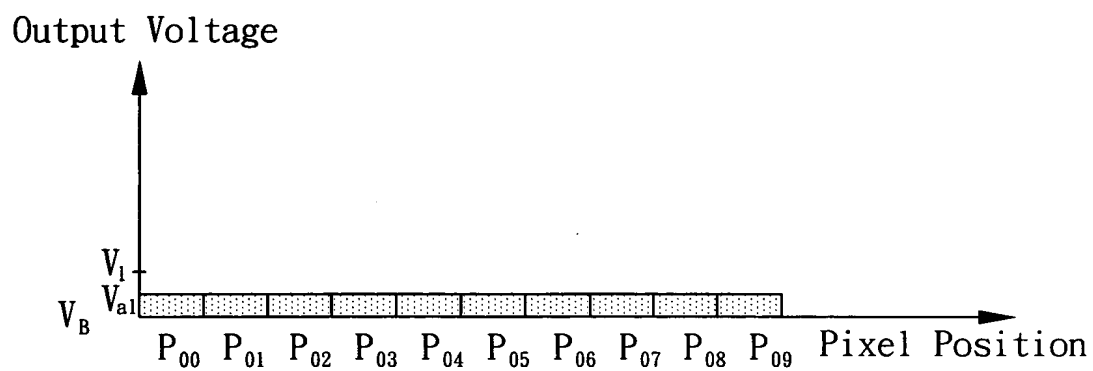

FIG. 5A

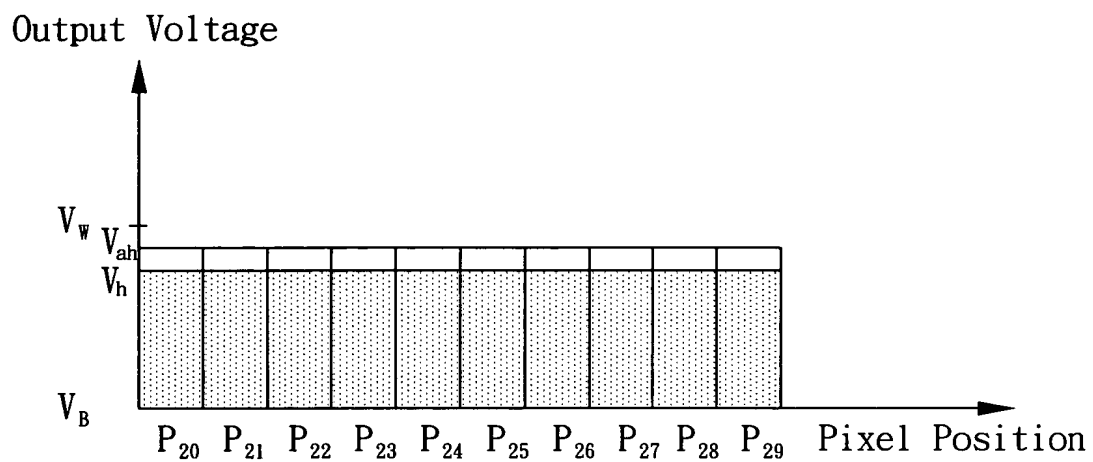

FIG. 5B

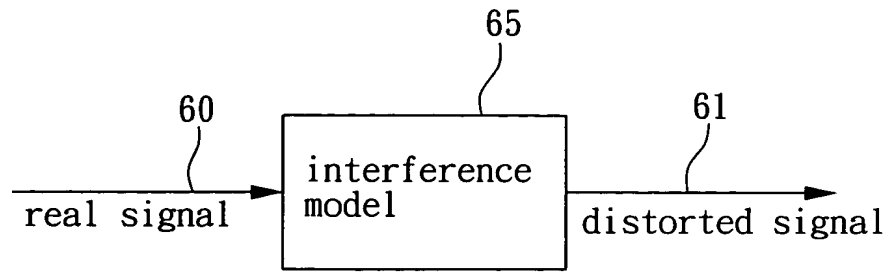

FIG. 6A

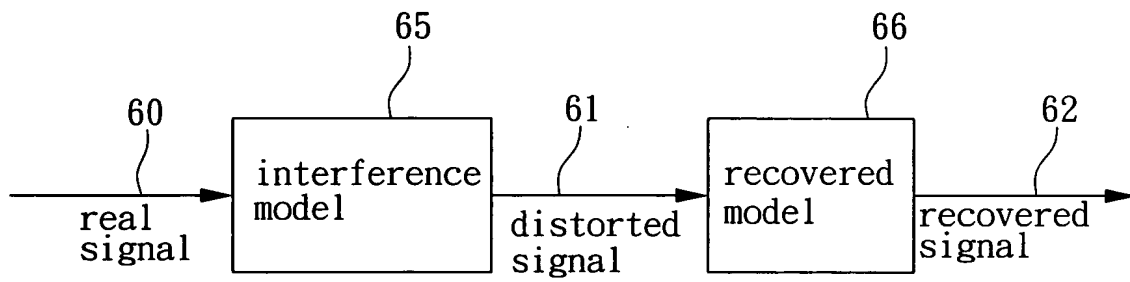

FIG. 6B

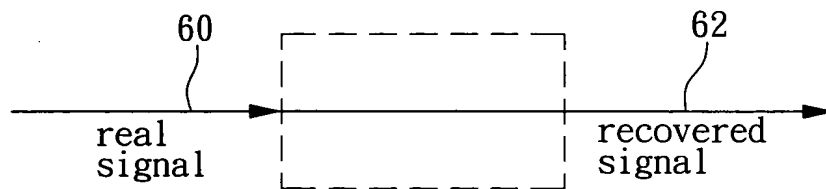

FIG. 6C

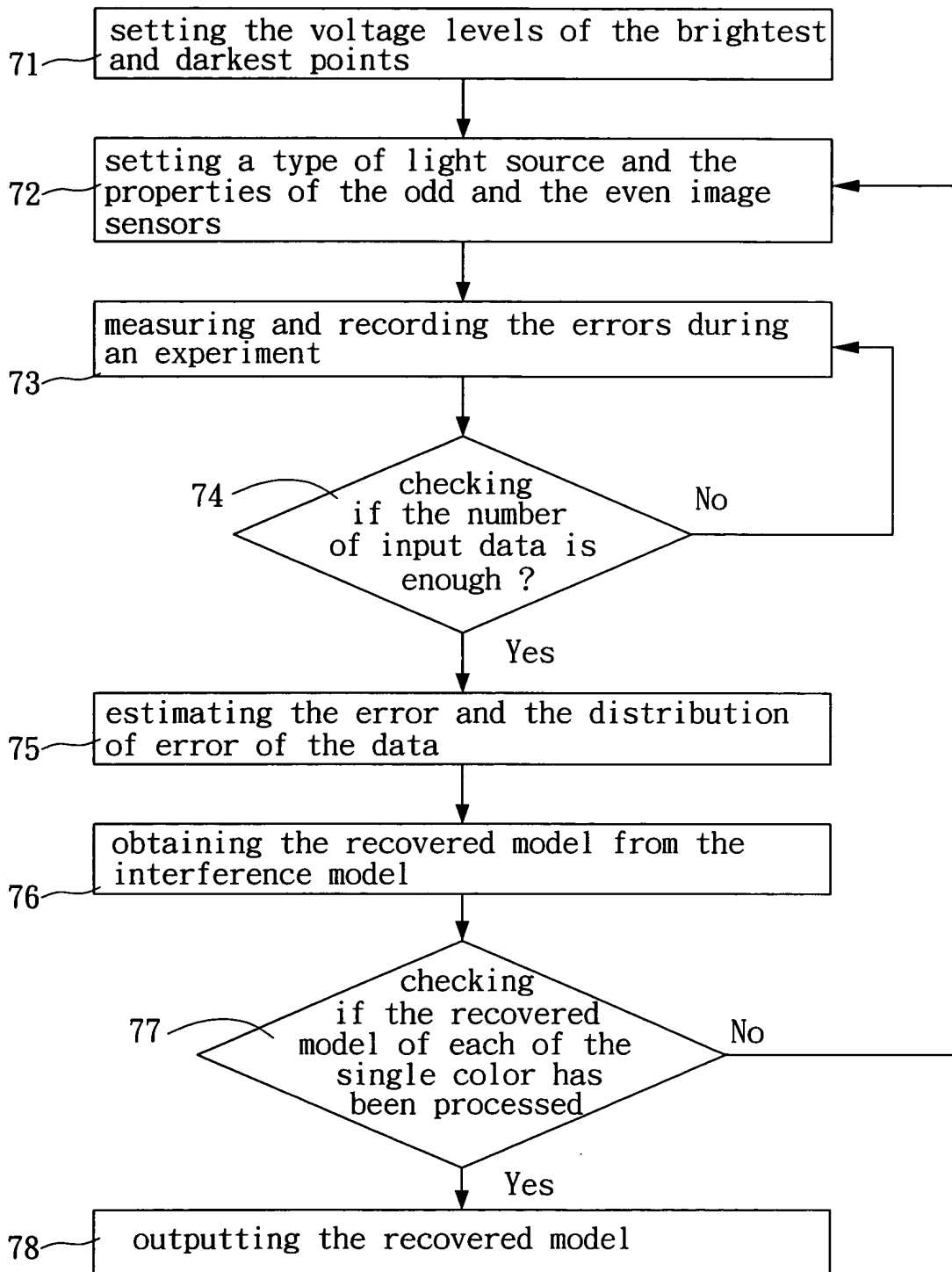

FIG. 7A



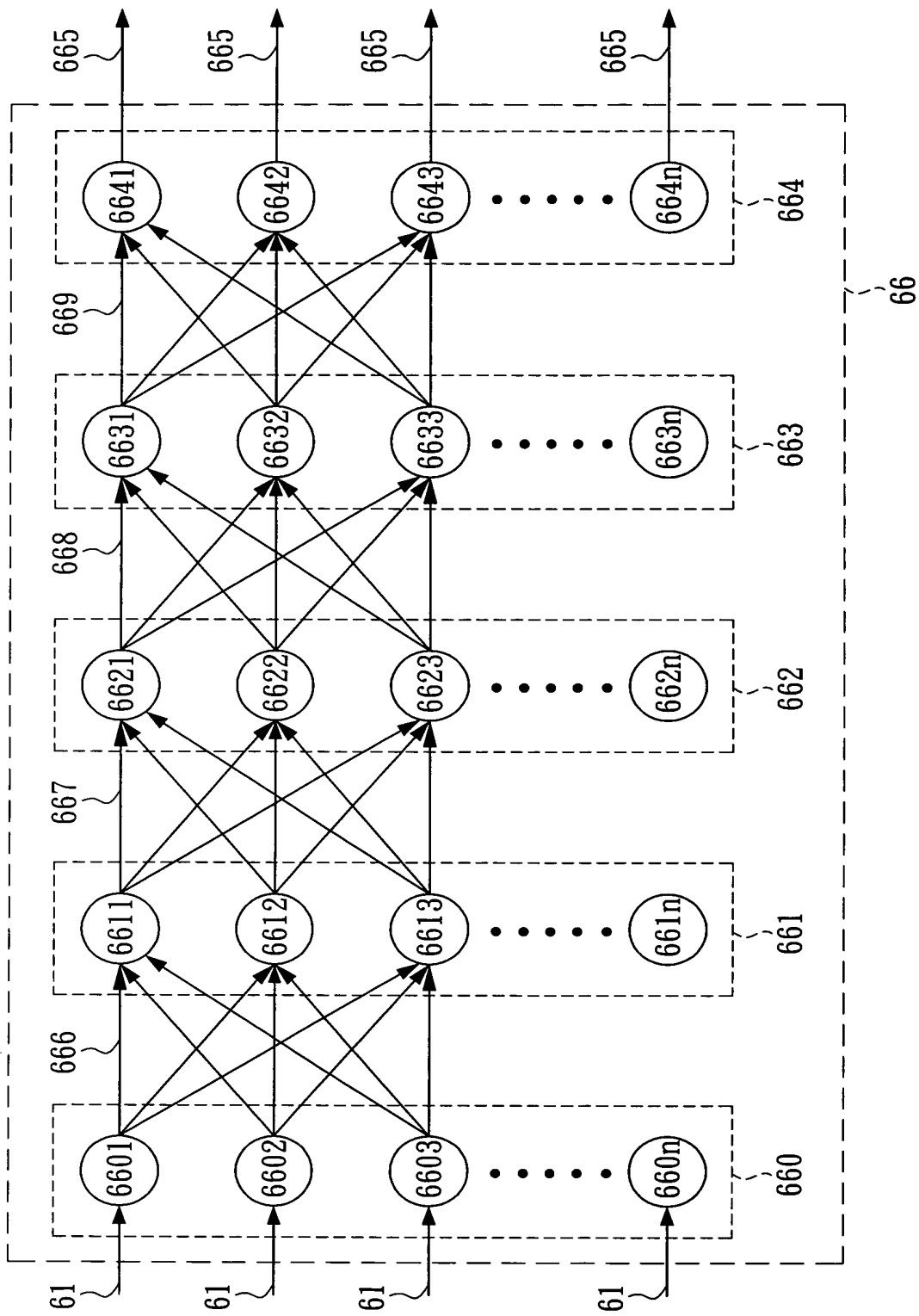

FIG. 7B

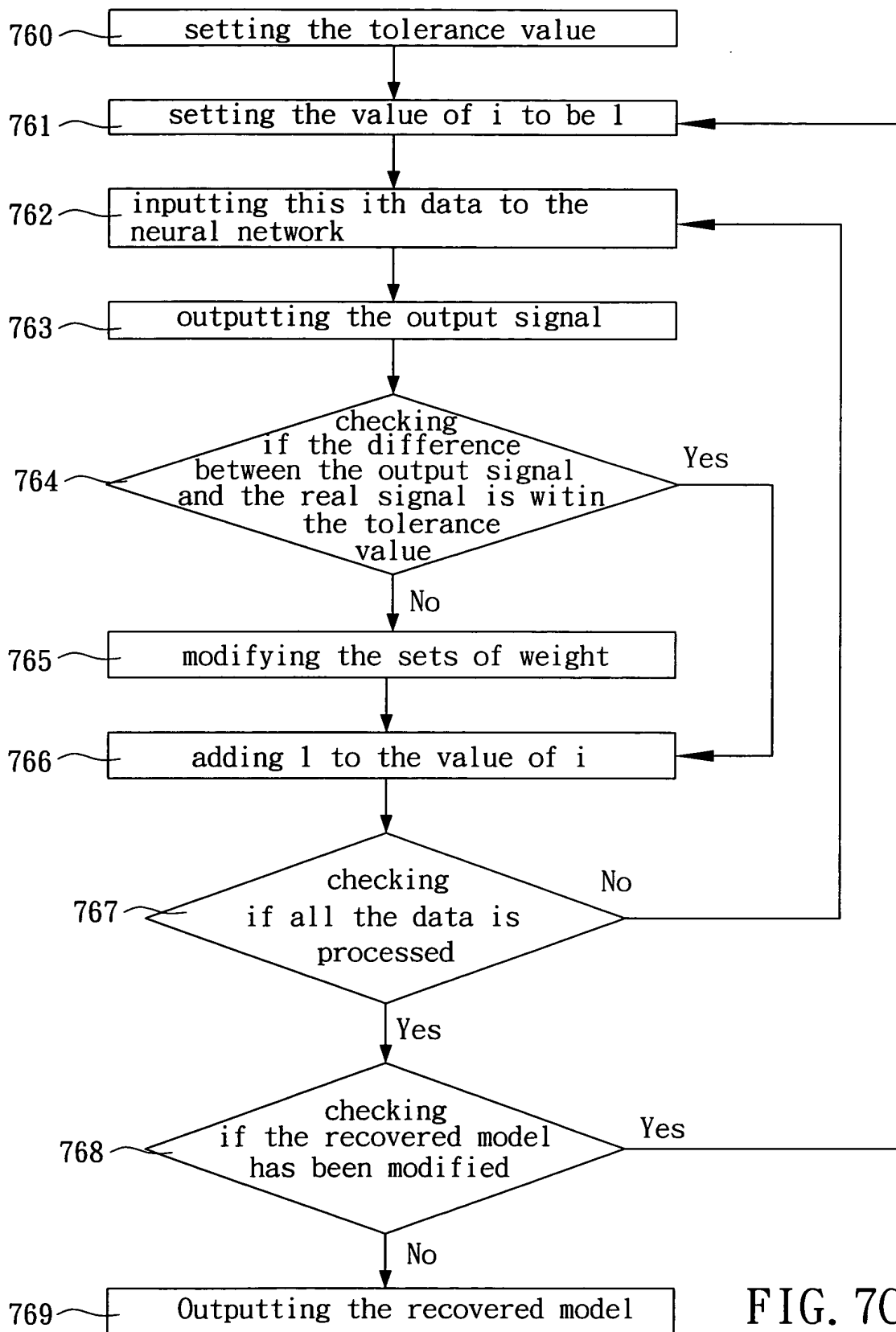

FIG. 7C

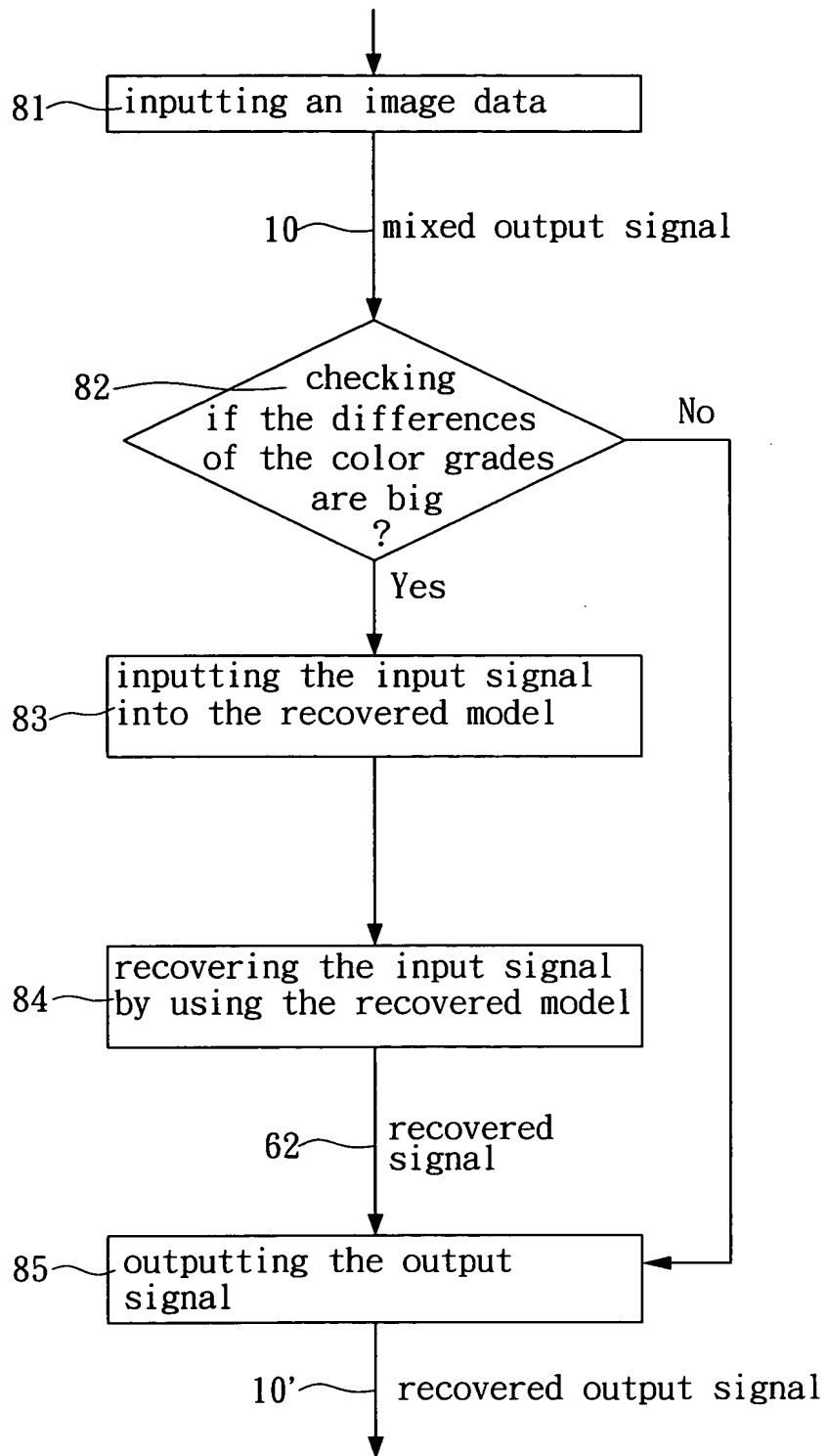

FIG. 8

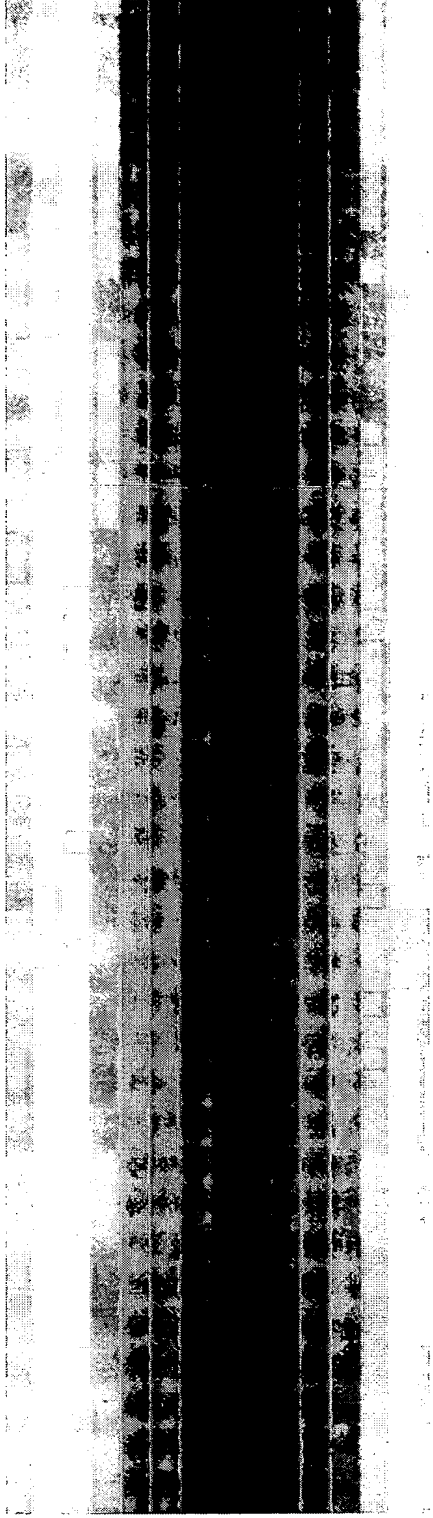

FIG. 9

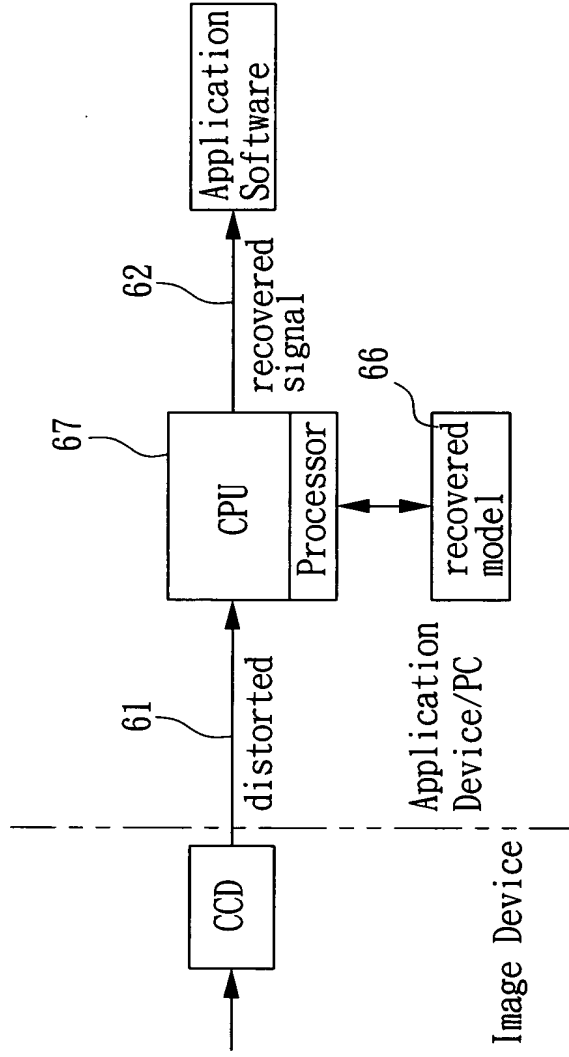

FIG. 10A

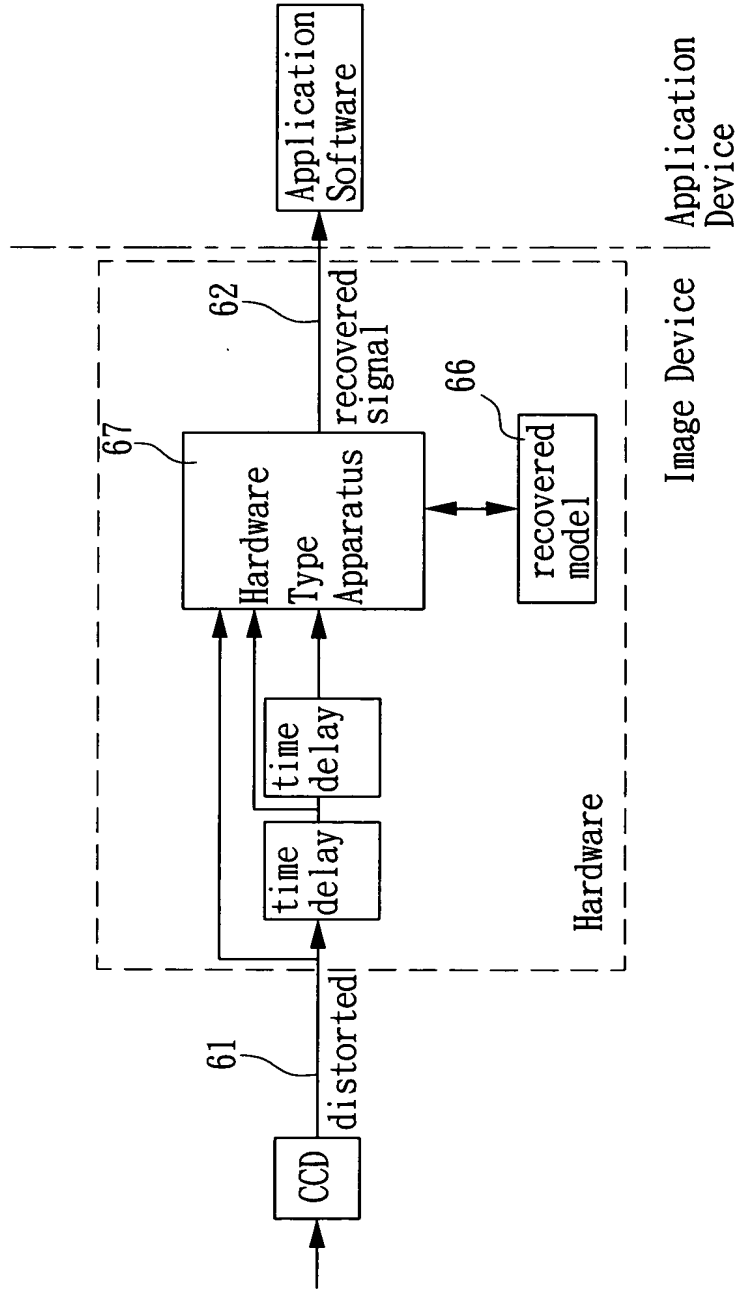

FIG. 10B

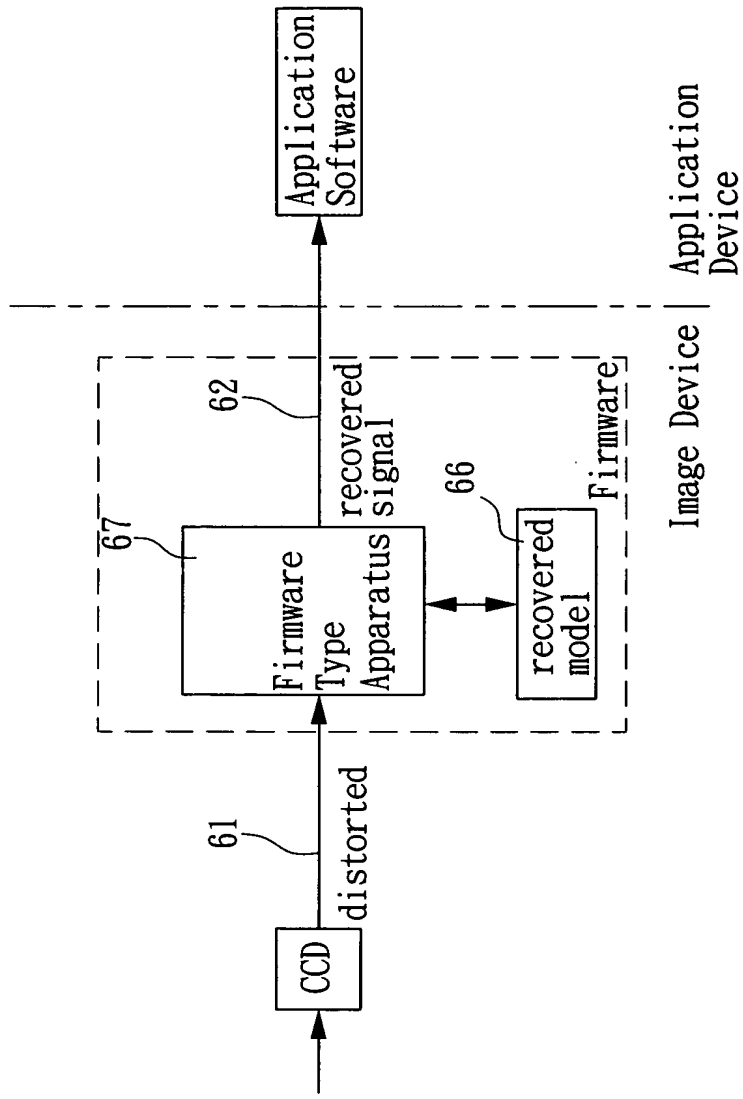

FIG. 10C